

The Research on PMSM Fuzzy Control in the Marine Electric Propulsion System

Wu Chao and Huang Huiying

*Department of Electrical Engineering and Automation in Luoyang
Institute of Science and Technology, Luoyang 471003
shiningi@163.com*

Abstract

Speed-regulation characteristic of PMSM (permanent magnet synchronous motor) in marine electric propulsion system is studied in this paper. Governing method based on vector control is analyzed according to the mathematical model in two-phase rotating coordinate system. After that, a noble PID control strategy which raises dual closed-loop i.e. speed loop and stator current loop is proposed based on fuzzy control theory. Speed deviation and its rate are taken as inputs for adjustment of the PID controller. The strategy proposed in this paper improves the response of system, static and dynamic characteristics of PMSM servo system as well as anti-jamming capability. Finally, simulation results from Simulink show the correctness and realizability of our system.

Keywords: *Electric Propulsion; Permanent Magnet Synchronous Machine; Vector Control; Fuzzy Control*

1. Introduction

Variable frequency speed regulation towards motor, especially PMSM plays a vital part in marine electric propulsion system. PMSM has lots of advantages over common motors such as small volume, reliability, high efficiency, wide frequency range and satisfactory characteristics. Recent research on PMSM has been focused on achieving faster response, better anti-jamming capability, higher steady-state accuracy and more steady transient process. Although classical PID controller is commonly used for PMSM control, it may not be the optimal choice due to its performance limitation. It performs well in case of LTI (linear time-invariant system) problem when accurate mathematical model is available. However, nonlinearity exists almost everywhere in real system which results in parameters changes during control process. So controller based on classical control theory doesn't fit for higher-level applications.

Fuzzy logic is an important branch of intelligent control [1, 2], which involves fuzzy set theory, fuzzy variables and fuzzy logic deduction [3]. In case of uncertain measurement result, huge data to deal with or variable object, fuzzy control has its advantages over conventional method. So fuzzy PID controller for PMSM is designed in this manuscript with dual closed-loop vector control. Simulation indicates the specifications such as response speed and overshoot has been improved. The system will adapt the complicated cases of load mutation and parameter changes with good dynamic performance.

2. Architecture of Marine Electric Propulsion System

Compared with conventional mechanical systems, marine electrical propulsion uses electrical machinery and has superiority in economy, vibration suppression, noise rejection, maneuverability and reliability [4]. Since last century, modern

power electronics technology has achieved great development, aiming for higher frequency, efficiency, and power factor, which introduced inverter technology to marine propulsion applications and makes a revolutionary headway. Electrical propulsion system consists of controller, inverter, propulsion motor, monitoring device and propeller. Scheme of electric propulsion system is shown in Figure 1.

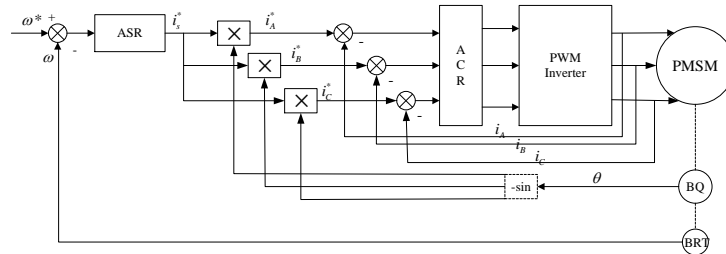

Figure 1. Scheme of PMSM Controller in Marine Electric Propulsion System

In this scheme, ASR(automatic speed regulator) and ACR(automatic current regulator) realize controls towards speed and current, respectively; parameters acquired by measurement are transmitted back to controller through feedback unit; PWM inverter provides power to propulsion motor according to instructions; propulsion motor serves as final executor and provides the required torque to propeller.

3. Mathematical Model of PMSM

Vector control simulates the torque control law of DC motor on AC motors. It takes flux of rotating motor as reference axis of space vector, and decomposes current vector into exciting current i_M producing flux and torque current i_T producing torque. i_M and i_T are orthogonal and controllable independently. In this case, accurate control towards torque and flux of PMSM can be realized just as DC motors, and the key issue of vector control still attributes control towards amplitude and space location (frequency and phase) of current vector [6].

Suppose PMSM with sinusoidal counter EMF (electromotive force), has linear magnetic path without magnetic saturation, hysteresis and eddy loss. Due to the constant stator flux, rotor vector control is applied, and mathematical model of PMSM in rotor d - q synchronized rotating coordinate is obtained as follows:

Flux equation of stator:

$$\psi_d = L_d i_d + \psi_f \quad (1)$$

$$\psi_q = L_q i_q \quad (2)$$

Voltage equation of stator

$$u_d = R_s i_d + p\psi_d - \omega_r \psi_q \quad (3)$$

$$u_q = R_s i_q + p\psi_q + \omega_r \psi_d \quad (4)$$

Torque and motion equation

$$T_e = \frac{3}{2} n_p (\psi_d i_q - \psi_q i_d) \quad (5)$$

$$T_e - T_L = J \frac{d\omega_r}{dt} + B\omega_r \quad (6)$$

in which: ψ_d, ψ_q are d- and q-axis components of stator flux; L_d, L_q are equivalent inductance of stator coil on d- and q-axis; i_d, i_q are d- and q-axis components of stator current; u_d, u_q are d- and q-axis components of stator voltage; ψ_f : rotor flux; R_s : coil resistance of stator; p : differential operator; ω_r : angular frequency of rotor; T_e : electromagnetic torque; n_p : pole number of motor; T_L : load torque; J : rotary inertia; B : viscosity coefficient.

In case of constant-speed operating range lower than fundamental speed, stator current is completely used to produce torque, that is: $i_d = 0, i_q = i_s$. Torque equation is:

$$T_e = \frac{3}{2} n_p \psi_f i_s \quad (7)$$

ψ_f is constant due to permanent magnet structure of rotor, so torque is only proportional to amplitude of stator current, which makes PMSM characteristic similar with DC motor and decoupling control can be achieved.

4. PID Control of PMSM

Simulation model of system with PI controller is shown in Figure2, which is realized in Simulink. The system consists of PI speed control module, coordinate transformation module, SPWM current tracking hysteresis controller module, motor module and monitoring module. Dual closed-loop system towards speed and current is provided with given speed 700rad/min . The difference between given speed and actual feedback speed is called speed error signal which is regulated by PI controller to obtain quadrature-axis current i_{qref} . With control method $i_{dref} = 0$, and giving direct-axis current $i_{oref} = 0$, current of 3-phase stator i_{abc} can be achieved through coordinate conversion. Through comparison with feedback current i_{abc} and modulation of SPWM current tracking hysteresis controller module, voltage of 3-phase stator is taken as the final control result.

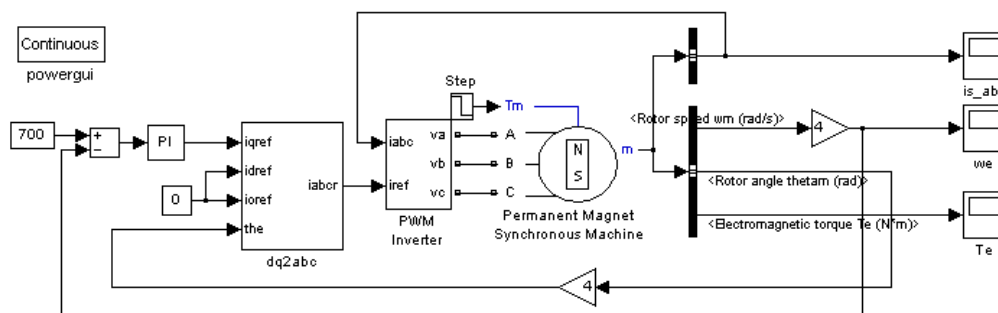

Figure 2. Simulation Model of Propulsion System

Specification of certain 3-phase sinusoid PMSM is listed below: Resistance of stator $R_s = 2.875\Omega$, d-axis component of stator inductance $L_d = 8.5\text{mH}$, q-axis component of stator inductance $L_q = 8.5\text{mH}$, rotational inertia $J = 0.008\text{kg} \cdot \text{m}^2$, number of pole pairs $n_p = 2$. Parameters of control system is set as follows: feedback coefficient $K_f = 50$; parameters of PI regulator: $K_p = 50, K_i = 2.6$. Load torque is treated as step signal, which steps from 3 to 1 at 0.04s indicating load change occurs. Speed, torque and stator current of PMSM system are shown in Figure 3, respectively.

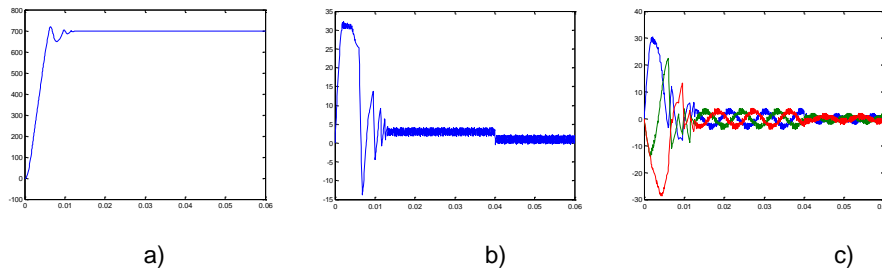

Figure 3. Response Curve of A) Speed, B) Electromagnetic Torque,

C) Stator Current

Some conclusions can be drawn from simulation results: motor speed reaches stable value at 700 rad/min after 22ms adjustment with about 3.5% overshoot. Electromagnetic torque oscillates from $-14\text{N}\cdot\text{m}$ – $32\text{N}\cdot\text{m}$ during startup, and stay stable at $3\text{N}\cdot\text{m}$ after transient process of 14ms . In case of load change, 2ms is taken from previous stable state $3\text{N}\cdot\text{m}$ to current stable state $1\text{N}\cdot\text{m}$. Response curve of stator current is similar with torque one, which oscillates from -30A – 30A before steady state and fluctuates when load changes.

Overall, the system is fairly stable and reliable, however, the static and dynamic characteristics can be improved.

5. Fuzzy PID Adaptive Control of PMSM

There are oscillation phenomenon during PI control process during the simulation in last chapter, which cannot be acceptable during real applications. Although we spent time to modify the PID parameters in our simulation, improvement of performance is hardly achieved. Moreover, in real applications, it is difficult to modify the control parameters for conventional PID controllers. When dynamic parameters of control object changes, the control effect will be affected.

Fuzzy control is a noble intelligent control based on fuzzy set, fuzzy variable and fuzzy logic. Basic fuzzy regulator consists of fuzzification, fuzzy inference and fuzzy decision modules, whose block diagram is shown in Figure 6[7, 8].

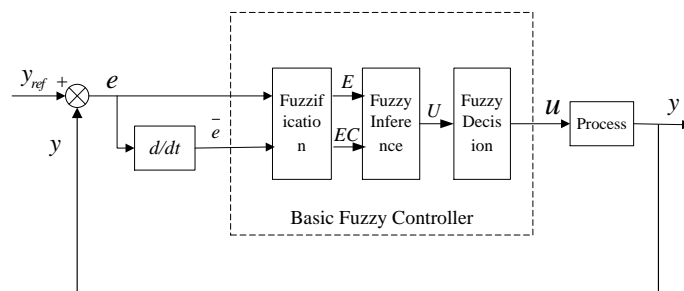

Figure 4. Block Diagram of Fuzzy Control

In Figure 4, e and \bar{e} are system error and error rate as input variables; u serves as output variable, E, EC, U are linguistic variables of system error, error rate and control output.

Fuzzy controller can modify its output component according to real-time change of system which is induced into conventional PID controller for performance improvement. The fuzzy adaptive PID controller calculates current error E and error rate EC , performs fuzzy inference according to rules and adjust parameters by looking up tables to improve system control ability.

Diagram of fuzzy adaptive PID controller is designed in Simulink, as shown in Figure 5. Controller modify the proportion, integration and differentiation parameters in real-time with fuzzy inference towards E and EC in order to achieve optimal control effect. Gain, Gain 1 and Gain 2 represent proportion P, integration I and Differentiation D; Product, Product 1 and Product 2 stand for calibration of proportion P, integration I and Differentiation D.

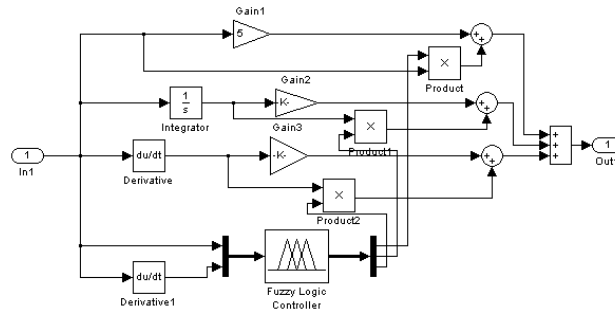

Figure 5. Architecture of Fuzzy Adaptive PID Controller

Control process of fuzzy PID controller is interprets as follows [7, 8]:

- 1) If E is large, larger k_p and smaller k_d are selected to improve to response speed and avoid oversaturation of differentiation at the beginning. And $k_i = 0$ for reducing overshoot.
- 2) If E is medium, k_i is no longer zero, but still keeps at a relative small value. k_p and k_d should be smaller than those in case 1 for response speed and stability.
- 3) If E is small, k_p and k_i can be large, while k_d is determined by EC with consideration of anti-jamming ability, that is: the larger EC is, the smaller k_d will be chosen.

5.1 Design of Fuzzy PID Controller

Fuzzy controller in Figure 7 is designed as follows: Fuzzy sets for E , EC and k_p , k_i , k_d are given as {NB, NM, NS, ZO, PS, PM, PB} with discourse domain of {-6, 6}.

Triangle membership function with symmetric distribution are selected for simplification. The membership function is larger when it is closer to origin, which improves the steady-state accuracy. Inference synthesis algorithm Mamdani is used as well as anti-fuzzification method of weighted average.

Membership function of input variable E is shown in Figure 6, and other variables have the similar curve with E .

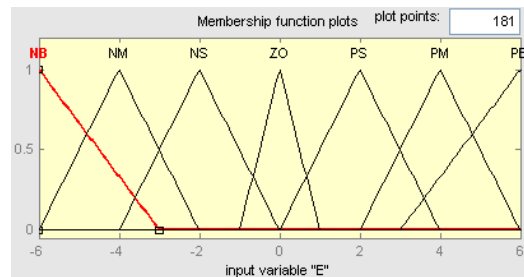

Figure 6. Membership of Input Variable E

According to control requirements of k_p , k_i and k_d during the process and their membership, through long-term trail-and-error and induction, fuzzy rules of k_p, k_i, k_d are listed in table 1-3:

Table 1. Fuzzy Rules For k_p

E	EC						
	NB	NM	NS	ZO	PS	PM	PB
NB	PB	PB	PM	PM	PS	ZO	ZO
NM	PB	PB	PM	PS	PS	ZO	NS
NS	PM	PM	PM	PS	ZO	NS	NS
ZO	PM	PM	PS	ZO	NS	NM	NM
PS	PS	PS	ZO	NS	NS	NM	NB
PM	PS	ZO	NS	NM	NM	NM	NB
PB	ZO	ZO	NM	NM	NM	NB	NB

Table 2. Fuzzy Rules For k_i

E	EC						
	NB	NM	NS	ZO	PS	PM	PB
NB	NB	NB	NM	NM	NS	ZO	ZO
NM	NB	NB	NM	NS	NS	ZO	ZO
NS	NM	NM	NS	NS	ZO	PS	PS
ZO	NM	NM	NS	ZO	PS	PM	PM
PS	NM	NS	ZO	PS	PS	PM	PM
PM	ZO	ZO	PS	PM	PM	PB	PB
PB	ZO	ZO	PS	PM	PM	PB	PB

Table 3 Fuzzy Rules For k_d

E	EC						
	NB	NM	NS	ZO	PS	PM	PB
NB	PS	NS	NB	NB	NB	NM	PS
NM	PS	NS	NB	NM	NM	NS	ZO
NS	NS	NS	NM	NM	NM	NS	ZO
ZO	ZO	NS	NS	NS	NS	NS	PS
PS	ZO	ZO	ZO	ZO	ZO	ZO	PS
PM	PB	NS	PS	PS	PS	PS	PB
PB	PB	PM	PM	PM	PS	PS	PB

5.2 Simulation Results

Simulation in Figure 2 is carried out again without any parameter modifications. Only common PI controller is replaced by the fuzzy PID adaptive controller designed in this chapter. Response curves of rotating speed, torque and stator current are shown in Figure 7.

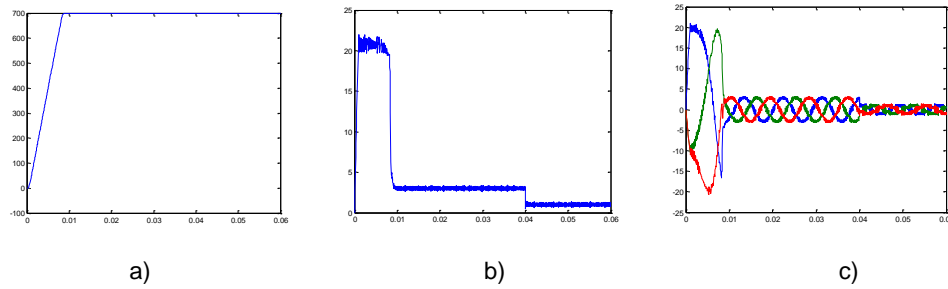

Figure 7. Improved Response Curve of A) Speed, B) Electromagnetic Torque, C) Stator Current

Compared with former results, it only costs the new system 8ms to reach steady state without overshoot and oscillations in speed curve. Load change seems no influence on speed. For response curve of torque, electromagnetic torque reaches $22N \cdot m$ rapidly and settle down to given $3N \cdot m$ without fluctuations. Even in case of load change, electromagnetic torque immediately follows the load torque. Curve of stator current is similar with former one, with smaller fluctuation range from $-20A-20A$. The new system is more stable with better static and dynamic characteristics, which fits for the requirement of high-performance servo system.

6. Conclusion

Fuzzy logic is applied in PMSM system in this manuscript for a noble adaptive controller with its advantages of nonlinearity, variable structure, self-learning, self-optimizing and self-tuning. The system with adaptive controller not only works smoothly but also eliminate the overshoot, shorten the starting and adjusting time. In one word, great improvement has been achieved.

Simulation results are compared and listed in table 4:

Table 4. Comparison between Fuzzy Controller and Conventional One

Controller	Start time (ms)	Adjustment time (ms)	Over-shoot	Fluctuation of torque ($N \cdot m$)	Fluctuation of stator current(A)
PI	22	2	3.5%	-14-32	-30-30
Fuzzy PI	8	0	0	0-22	-20-20

Conclusion can be drawn from the comparison:

- (1) Parameters of conventional PI controller cannot be modified conveniently so it may be not the best choice in complicated industrial environment. Oscillation and overshoot may occur during control process which makes it unsuitable for high-level application.
- (2) Fuzzy adaptive PID controller combines the best of fuzzy control and PID, tuning the three parameters of PID in real-time based on fuzzy logic to satisfy the case of variable error. Simulation results indicate the control method proposed eliminate the overshoot, suppress the disturbance with better static and dynamic response.

References

- [1] G.Y. Li, "Intelligent Control and its Matlab Realization", Electronic Industry Press, (2005).
- [2] J.Q. Han and P. Zheng, "A Simplified Direct Torque Control Method of PMSM Applied in Electric Vehicles", Transactions on China electrotechnical society, vol. 24, no. 1, (2009).
- [3] S. Liu and D.H. Xu, "Intelligent Control for Principal Axis of Variable Vector Propeller of Submersible Vehicle", Proceedings of 8th International Conference on Intelligent System Design and Applications, (2008), Kaohsiung, Taiwan.

- [4] D.C. Jin, M.W. J and J.F. Yun, "Principle of Marine Electric Propulsion", National Defense Industry Press, (1993).
- [5] S.G. Tao, D.K. Yuan and H. Liu, "Improvement on Direct Torque Control of Permanent Magnet Synchronous Motor", Journal of Tongji University (Natural science), vol. 33, no.5, (2005).
- [6] C.H. Zhang, N.X. Cui and K. Li, "AC motor variable frequency speed control and its application", China Machine Press, (2008).
- [7] J.H. Feng and J.F. Xu, "A New Torque Adjustment Method of Permanent Magnet Synchronous Machines Direct Torque Control System", A Journal of the Chinese Society for Electrical Engineering, vol. 13, no. 26, (2006).
- [8] M. Yang and W. Xie, "The Computer's Simulation of 6-phase Synchronous Motor Supplied by Voltage-source Inverter", Electrical Engineering, vol. 7, (2007).

Authors

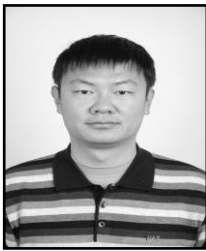

Wu Chao, He received his Master Degree in Electronics Engineering from Politecnico di Torino in Italy in 2009. He is currently student in Department of Electrical Engineering & Automation at Harbin Institute of Technology for his Doctor Degree. Main research direction involves intelligent control and battery management system.

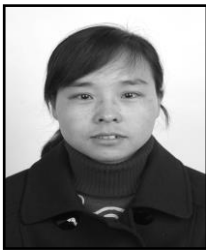

Huang huiying, He received her Master Degree in Electronics Science and Technology from Zhengzhou University in 2007. She has 6 years of teaching experience and currently works as lecturer in Department of Electrical Engineering & Automation in Luoyang Institute of Science and Technology.